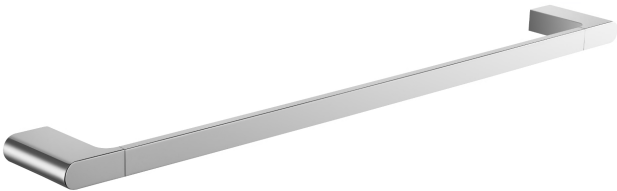
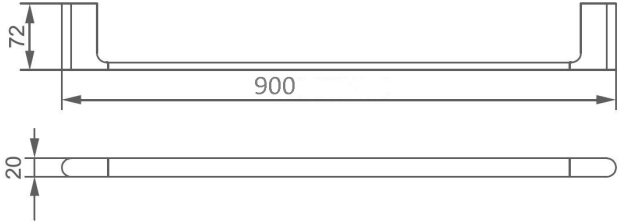

## Sync Single Towel Rail 900mm

Product Image	Technical Specification
	

Description	Attributes						
<p>Sync Single Towel Rail 900mm</p> <table border="0"> <tr> <td><b>YS1115</b></td> <td>Chrome</td> </tr> <tr> <td><b>YS11151</b></td> <td>Matte Black</td> </tr> <tr> <td><b>YS11152</b></td> <td>Brushed Nickel</td> </tr> </table>	<b>YS1115</b>	Chrome	<b>YS11151</b>	Matte Black	<b>YS11152</b>	Brushed Nickel	<ul style="list-style-type: none"> <li>• Made from top quality brass</li> <li>• Warranty : 7/1 years</li> </ul>
<b>YS1115</b>	Chrome						
<b>YS11151</b>	Matte Black						
<b>YS11152</b>	Brushed Nickel						

\*All dimensions are in millimeters and are subject to normal manufacturing variations. Actual dimensions should be checked prior to installation. Yushi pursues a policy of continuing improvement in design and performance of its products. The right is therefore reserved to vary specifications without notice.