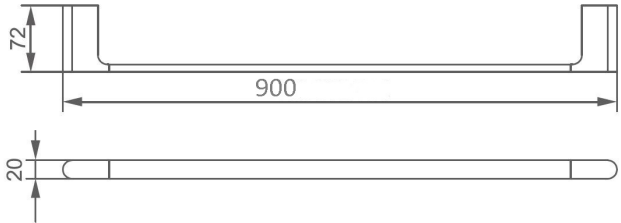

Sync Single Towel Rail 900mm

Product Image	Technical Specification
	

Description	Attributes						
<p>Sync Single Towel Rail 900mm</p> <table border="0"> <tr> <td>YS1115</td> <td>Chrome</td> </tr> <tr> <td>YS11151</td> <td>Matte Black</td> </tr> <tr> <td>YS11152</td> <td>Brushed Nickel</td> </tr> </table>	YS1115	Chrome	YS11151	Matte Black	YS11152	Brushed Nickel	<ul style="list-style-type: none"> • Made from top quality brass • Warranty : 7/1 years
YS1115	Chrome						
YS11151	Matte Black						
YS11152	Brushed Nickel						

*All dimensions are in millimeters and are subject to normal manufacturing variations. Actual dimensions should be checked prior to installation. Yushi pursues a policy of continuing improvement in design and performance of its products. The right is therefore reserved to vary specifications without notice.