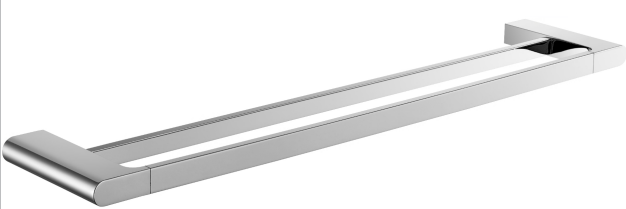
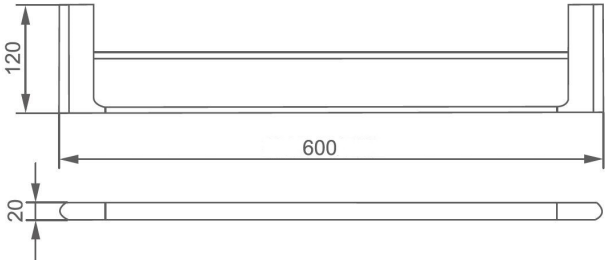

Sync Double Towel Rail 600mm

Product Image	Technical Specification
	

Description	
Sync Double Towel Rail 600mm	
YS1110	Chrome
YS11101	Matte Black
YS11102	Brushed Nickel

Attributes
<ul style="list-style-type: none"> • Made from top quality brass
<ul style="list-style-type: none"> • Warranty : 7/1 years

*All dimensions are in millimeters and are subject to normal manufacturing variations. Actual dimensions should be checked prior to installation. Yushi pursues a policy of continuing improvement in design and performance of its products. The right is therefore reserved to vary specifications without notice.